

SonicMat:

A FULL RANGE OF HIGH PERFORMANCE ACOUSTIC MATS

8/4 - 15/7 - 17/8 - 20/10

TECHNICAL INFORMATION SHEET

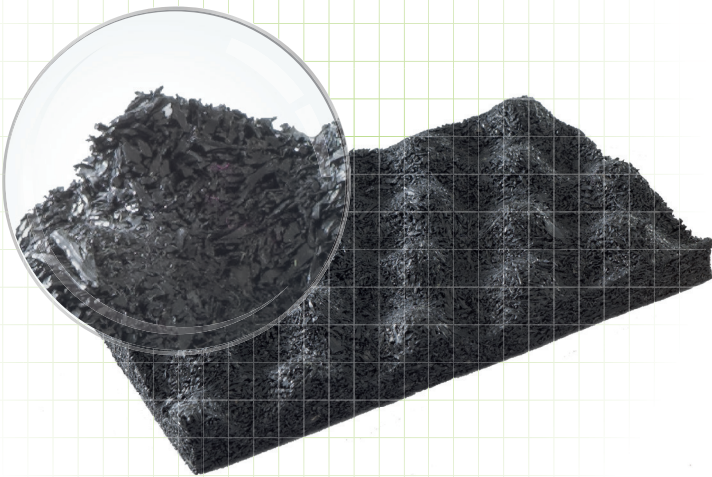

PRODUCT DESCRIPTION

The SonicMat range is composed of high-grade recycled rubber fibres coming from aircraft tyres or car tyres with a PU elastomer bonding agent. It is designed to isolate screeds from the main structure of the building, reducing impact energy generated by general footfall. With a wavy surface on bottom side, which reduces dynamic stiffness, increases air movement and dissipates energy in channels, the SonicMat offers enhanced isolation performance.

APPLICATIONS

The SonicMat Range offers high impact acoustic improvement in

- Hospitals
- Office Spaces
- Hotels
- Cinemas
- Residential Buildings
- Schools & Libraries
- Shopping Malls
- Rail Stations

BENEFITS

- Made in Belgium and backed by several independent laboratory and field tests
- Excellent material performance with a significant sound impact improvement
- Outstanding elasticity
- Resistant to ageing and deformation
- Minimizes construction heights
- Environmentally friendly : 100% recycled and recyclable
- Quick and easy installation
- Suitable for use with underfloor heating

INSTALLATION GUIDELINES AND SERVICES

- Please refer to the RubberGreen installation guidelines,
- In addition to supply of this product our Partner offers an installation service. Use of our recommended Partner service ensures that installation is performed to the highest standards by tradesmen fully experienced in the specialist skills of fitting acoustic materials correctly.





Physical & technical information

	8/4	15/7	17/8	20/10	2x 20/10
Impact sound improvement ΔL_w (EN ISO 10140-3:2010)	25 dB	28 dB	28 dB	31 dB	37 dB
Dynamic stiffness (EN29052)	30 MN/m ³	20 MN/m ³	18 MN/m ³	15 MN/m ³	7,5 MN/m ³
Natural frequency (at $\sigma = 0,05$ N/mm ²)	30 Hz	20 Hz	19 Hz	17 Hz	12 Hz
Dimensions	10 x 1 m	1,7 x 1,2 m	1,7 x 1,2 m	1,7 x 0,6 m	1,7 x 0,6 m
Thickness	8 mm	15 mm	17 mm	20 mm	40 mm
Material	SBR rubber granules from recycled tyres bonded with PU	Natural rubber from recycled aircraft tyres bonded with PU			
Density	700 kg/m ³	650 kg/m ³			
Surface	Flat top side and wavy bottom side				
Colour	Black				
Maximum Permanent load	5000 kg/m ²				
Tensile strength (ISO 1798)	approx. 0,3 N/mm ²				
Elongation at break (ISO 1798)	approx. 45%				
Temperature resistance	-40° to 80°				
Fire Classification (EN 13501-1)	Efl				
Thermal conductivity	0,14 W/mK				
Durability	Lifetime of the Building				

ACOUSTIC PERFORMANCE

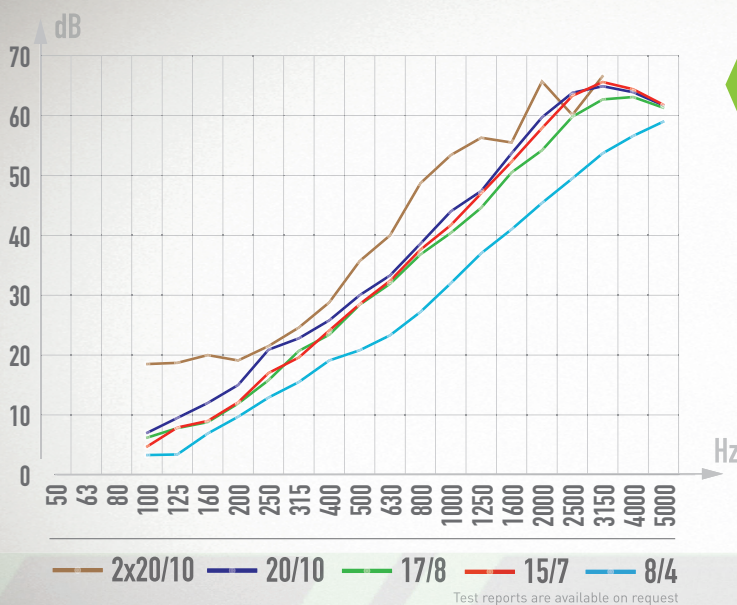

Frequency (Hz)	8/4	15/7	17/8	20/10	2x20/10
50					
63					
80					
100	3,3	4,7	6,2	7	18,5
125	3,4	7,9	7,8	9,5	18,7
160	6,9	9	8,8	12	20
200	9,7	12,1	11,9	15	19,1
250	12,9	17	15,8	20,9	21,5
315	15,5	19,6	20,7	22,8	24,6
400	19,1	24,1	23,4	25,8	28,8
500	20,8	28,5	28,4	30	35,7
630	23,3	32,4	31,9	33,3	40
800	27,2	37,6	36,8	38,6	48,7
1000	32	41,7	40,4	44	53,4
1250	37	47	44,6	47,4	56,3
1600	41	52,3	50,5	53,7	55,5
2000	45,4	57,9	54,2	59,7	65,7
2500	49,5	63,3	59,8	63,8	60,1
3150	53,7	65,6	62,7	64,9	66,6
4000	56,6	64,4	63,1	63,9	
5000	59	61,8	61,3	61,7	



Installation Scheme

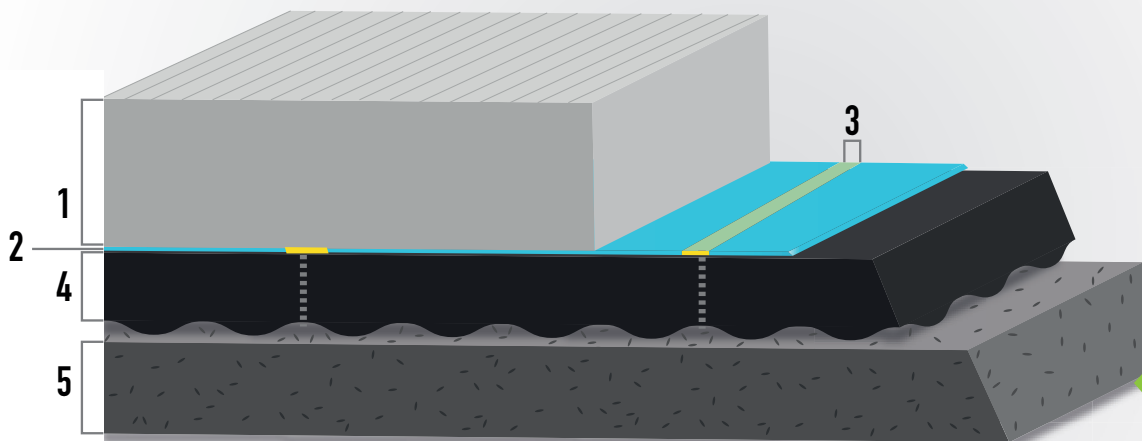

- 1. 60mm sand cement screed or under screed and tiles
- 2. 0,2mm PE-protection membrane
- 3. Taped joint
- 4. SonicMat
- 5. Concrete slab
- 6. Perimeter protection

For example purposes only

Perimeter detail

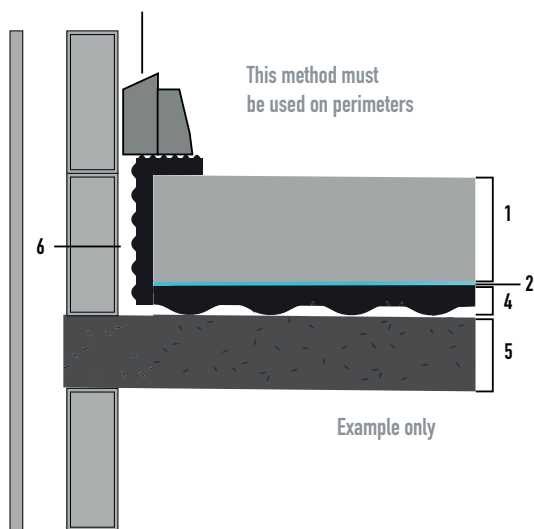

Example only

Joint detail

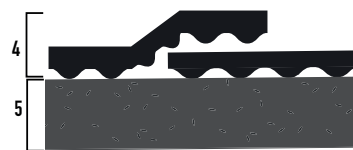

Example only

Alternative Joint Detail (buted)

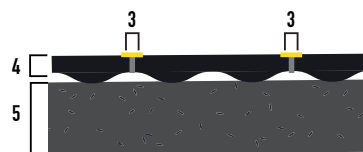

Example only

1

Other related products & RubberGreen the company

RUBBERWALL : BEARING JOINTS FOR WALLS

To maximize the efficiency of the SonicMat system, RubberGreen has created RubberWall, a heavy-duty masonry insulation material that disconnects the walls from their base and acts as a decoupling filter which reduces structure-borne noise transmission between floors (K_f flanking transmission). Capable of bearing loads up to 1,5 MPa in his hardest version, this material is particularly resistant and keeps its resilience over time. With a thickness of 10 mm, it is delivered in 100, 150 or 200 mm wide strip rolls of 6 m long.

Visit www.rubberwall.eu for more information

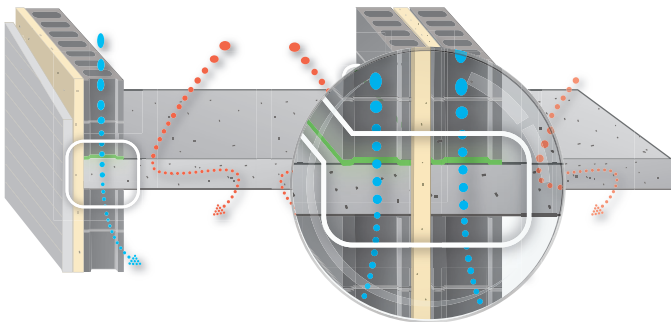

SONICMAT FIBER AND RUBBERMAT FIBER : MASS-SPRING SYSTEM

SonicMat Fiber is a similar product range than SonicMat, specifically adressed for antivibration issues. Also made from high-grade natural rubber fibers coming from recycled aircraft tyres, SonicMat Fiber has a flat top side and a wavy bottom side. Available thicknesses are 10/5, 15/7, 17/8, 20/10 and 25/10. Under floating concrete slab of 25 cm, one layer of SonicMat 25/10 has a resonance frequency of 12 Hz (less than 10 Hz with two layers). Attenuation of vibration level is more than 20 dB. For heavier loads, we propose RubberMat Fiber with two flat sides and thicknesses from 20 mm up to 100 mm.

THE COMPANY SHORT PRESENTATION

RubberGreen the specialist of composite recycled rubber material, designs and manufactures products and solutions for noise and vibration insulation, mechanical protection, shock absorption, anti-slip protection,... for the following sectors :

- Construction & building
- Railways
- Roof support systems
- Industries

RubberGreen is an international and innovative company founded on a green vision, giving a second life to rubber waste otherwise destined for destruction or burial. R&D and customer satisfaction are at the center of our concerns.

RubberGreen

RubberGreen Industrie SA
Rue de la Sucrierie, 10
7080 Frameries - Belgium
Ph.+32 (0)65 80 15 60
Fax +32 (0)65 63 49 08
info@RubberGreen.be

For further information:
www.rubbergreen.eu

The information provided is intended only as a summary and general overview on matters of interest.

The information is not intended to be comprehensive nor does it constitute expert advice. RubberGreen shall not be liable for incidental and/or consequential damages directly or indirectly sustained, nor any loss caused by not complying with relevant industry/product standards and improper use of any RubberGreen products. Due to varying construction methods, any other circumstances not stated above should be brought to the attention of RubberGreen for review. For suitability to the prevailing site conditions, it is advised that certified testing should be conducted. It is recommended to seek further advice on your application with our Partner or our technical staff prior to use.